

Dew

GCA Architects

Lámpara circular sin cable de alimentación (alimentación por tensores). Fabricada en tubo de aluminio curvado, módulos lumínicos de 4,2 W de potencia fabricados en aluminio mecanizado. Florón circular registrable para instalación en superficie.

Circular lamp without power cable (power by tensors). Made of curved aluminum tube, 4.2 W power lighting modules made of machined aluminum. Registrable circular ceiling rose for surface installation.

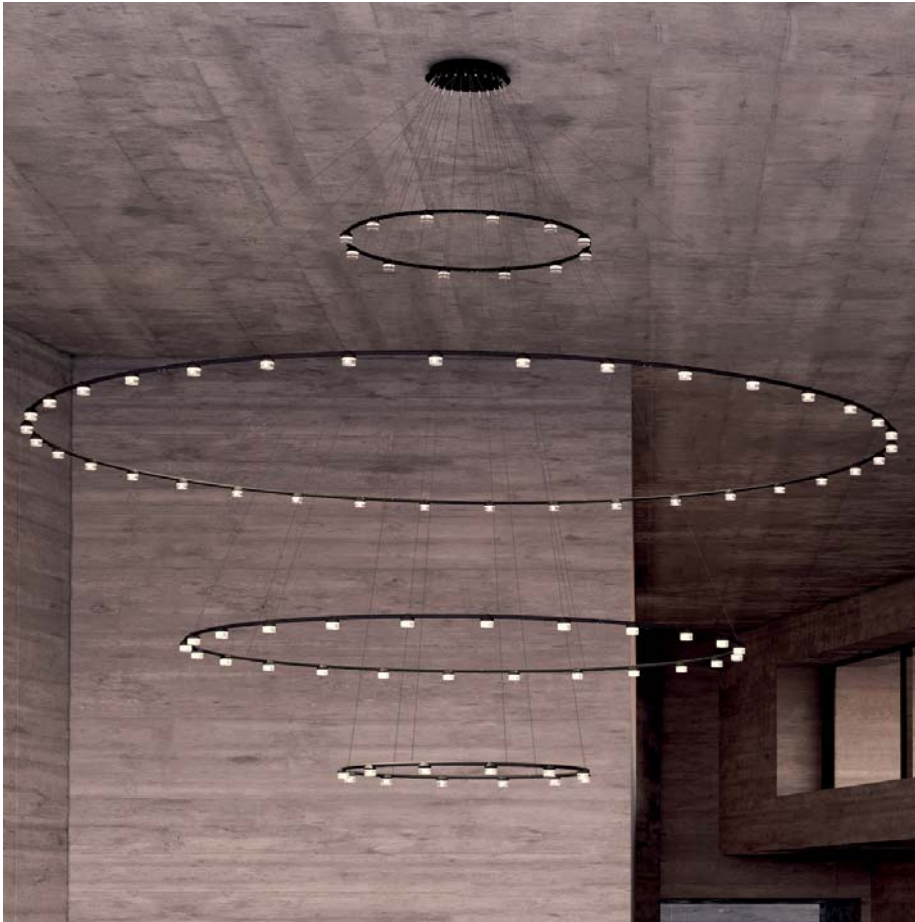

Dew 60 1700



Dew 130 1701

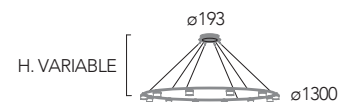

Dew 290 1702

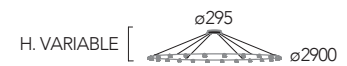

Dew 450 1703

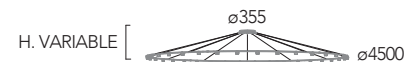

Luz / light

- 1700** - LED 25,2W 2400lm
- 1701** - LED 50,4W 4800lm
- 1702** - LED 100,8W 9600lm
- 1703** - LED 151,2W 14400lm

200/240V 50/60Hz 2700K - 3000K

Acabados / Finishes

- Blanco / White
- Negro / Black
- Dorado / Golden



Dimmable: TRIAC



Luz spots / Spot light



INSOLIT

c/ Cerignola 13, 08022 Barcelona
+34 932 507 640 • insolit@insolitbcn.com • **insolitbcn.com**

1700

Dew 60



Lámpara circular sin cable de alimentación (alimentación por tensores). Fabricada en tubo de aluminio curvado de 600 mm de diámetro. 6 módulos lumínicos de 4,2 W de potencia fabricados en aluminio mecanizado. Florón circular registrable para instalación en superficie.

Circular lamp without power cable (powerer by tensors). Made of 600 mm diameter curved aluminum tube. 6 lighting modules of 4.2 W power made of machined aluminum. Registrable circular rosette for surface installation.

Código / Code	1700
Acabados / Finishes	01 Blanco / White 03 Negro / Black 05 Dorado / Golden
Luz / Light	27 LED 25,2W 2400lm 2700K 30 LED 25,2W 2400lm 3000K
Regulación / Dimmable	TRIAC
Opcional / Optional	Dimmable: DALI 1-10V Casambi (Control de la luz via Bluetooth y App) (Lighting control via Bluetooth and App)
Diseñador / Designer	GCA Architects
Año / Year	2024
Peso / Weight	2,9 kg
Material	Aluminio / Aluminium
Alimentación LED / LED tension	200/240V 50/60Hz
IRC / CRI	90
Dimensiones embalaje / Box Dimensions	75x75x10 cm

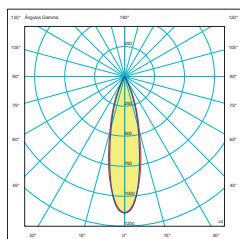
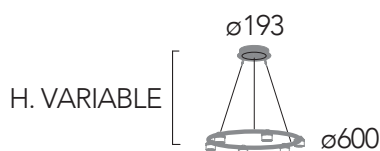

Instalación / Installation
Unión de los sectores mediante tornillos Allen M4 (Excepto Dew 600). Tornillos de fijación del florón no incluidos de serie. Cables de suspensión / alimentación protegidos.

Union of the ring sectors using M4 Allen screws (Except Dew 600). Ceiling fixing screws not included as standard. Protected suspension / power cables.



Luz spots / Spot Light



Dimmable: TRIAC



Fotometrías completas disponibles en
Full photometrics on: www.insolitbcn.com

Fabricado según normativa EN60598-1 y regulaciones pertinentes.

Manufactured according EN60598-1 normative and relevant regulations.

Dew 60

GCA Architects

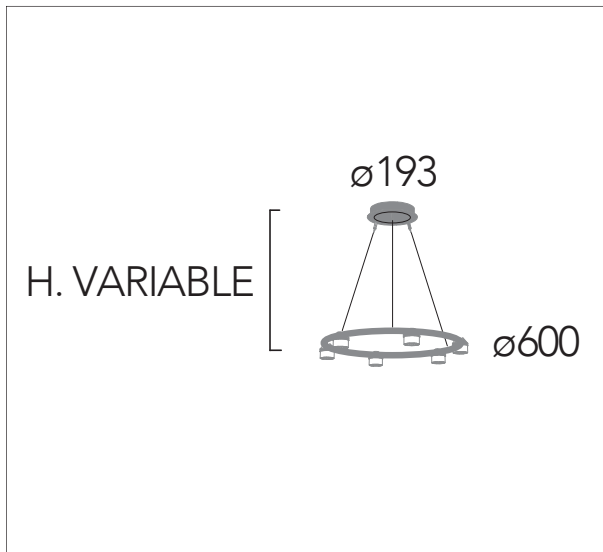

INSOLIT

c/ Cerignola, 13
08022 Barcelona
+34 932 507 640
insolit@insolitbcn.com
insolitbcn.com

Dew 60

GCA Architects

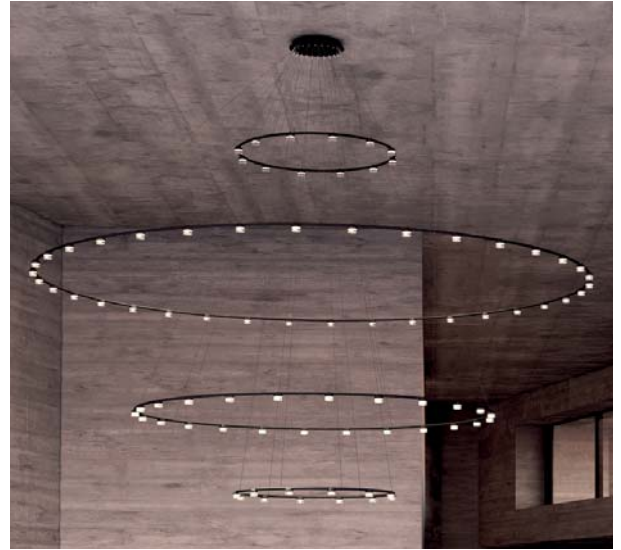

1700XX03

Instrucciones de montaje
Installation instructions

INSOLIT

Instalación y conexión / Installation and Connection

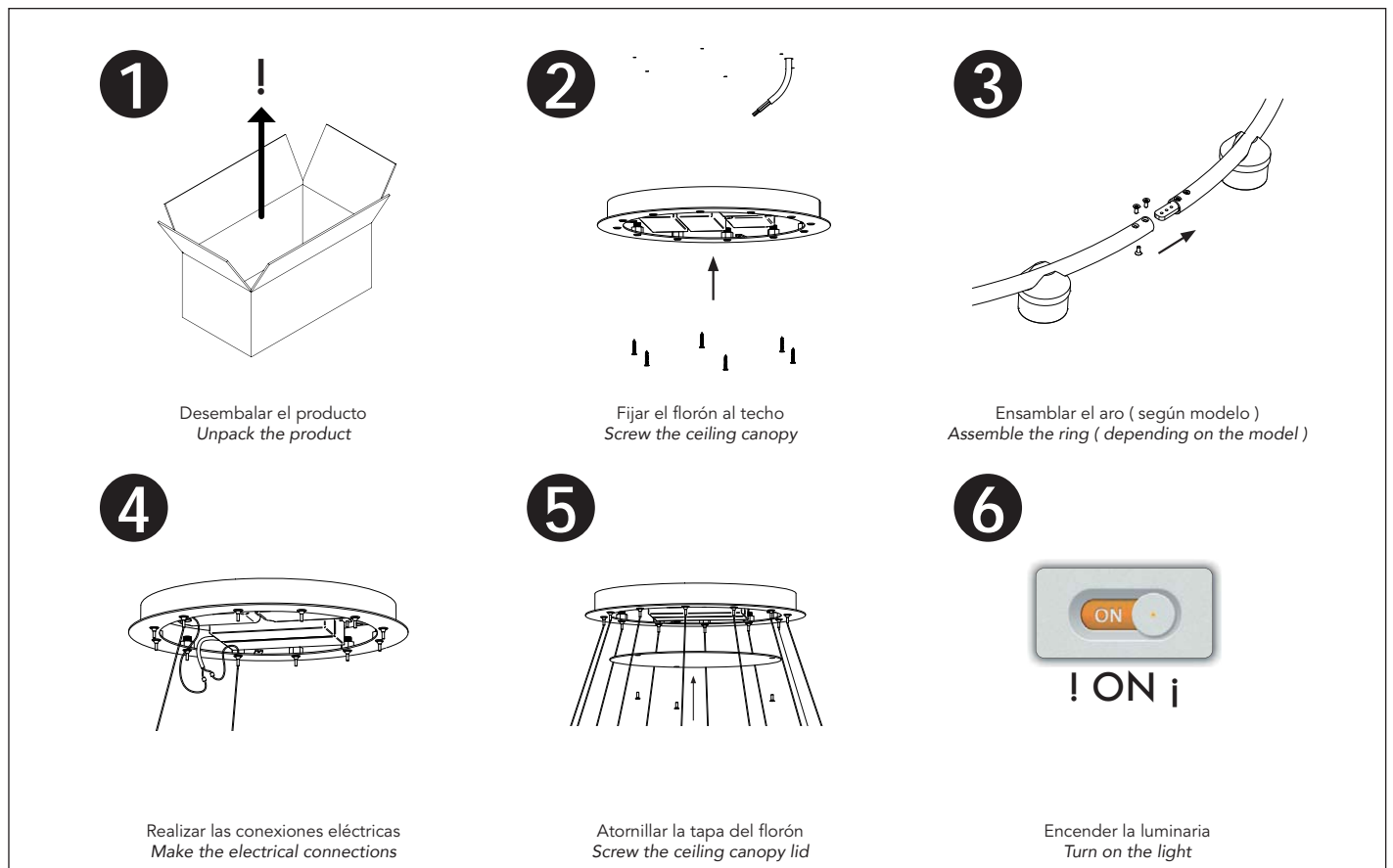

1701

Dew 130



Lámpara circular sin cable de alimentación (alimentación por tensores). Fabricada en tubo de aluminio curvado de 1300 mm de diámetro. 12 módulos lumínicos de 4,2 W de potencia fabricados en aluminio mecanizado. Florón circular registrable para instalación en superficie.

Circular lamp without power cable (powerer by tensors). Made of 1300 mm diameter curved aluminum tube. 12 lighting modules of 4.2 W power made of machined aluminum. Registrable circular rosette for surface installation.

Código / Code	1701
Acabados / Finishes	01 Blanco / White 03 Negro / Black 05 Dorado / Golden
Luz / Light	27 LED 50,4W 4800lm 2700K 30 LED 50,4W 4800lm 3000K
Regulación / Dimmable	TRIAC
Opcional / Optional	Dimmable: DALI 1-10V Casambi (Control de la luz via Bluetooth y App) (Lighting control via Bluetooth and App)
Diseñador / Designer	GCA Architects
Año / Year	2024
Peso / Weight	4,7 kg
Material	Aluminio / Aluminium
Alimentación LED / LED tension	200/240V 50/60Hz
ICR / CRI	90
Dimensiones embalaje / Box Dimensions	140x100x10 cm

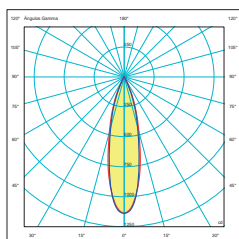
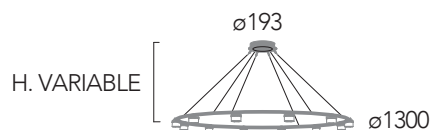

Instalación / Installation
Unión de los sectores mediante tornillos Allen M4 (Excepto Dew 600). Tornillos de fijación del florón no incluidos de serie. Cables de suspensión / alimentación protegidos.

Union of the ring sectors using M4 Allen screws (Except Dew 600). Ceiling fixing screws not included as standard. Protected suspension / power cables.



Luz spots / Spot Light



Dimmable: TRIAC



Fotometrías completas disponibles en
Full photometrics on: www.insolitbcn.com

Fabricado según normativa EN60598-1 y regulaciones pertinentes.

Manufactured according EN60598-1 normative and relevant regulations.

Dew 130

GCA Architects

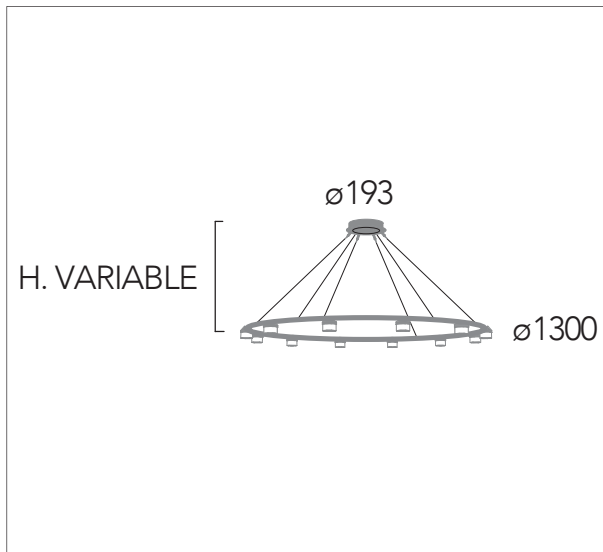

INSOLIT

c/ Cerignola, 13
08022 Barcelona
+34 932 507 640
insolit@insolitbcn.com
insolitbcn.com

Dew 130

GCA Architects

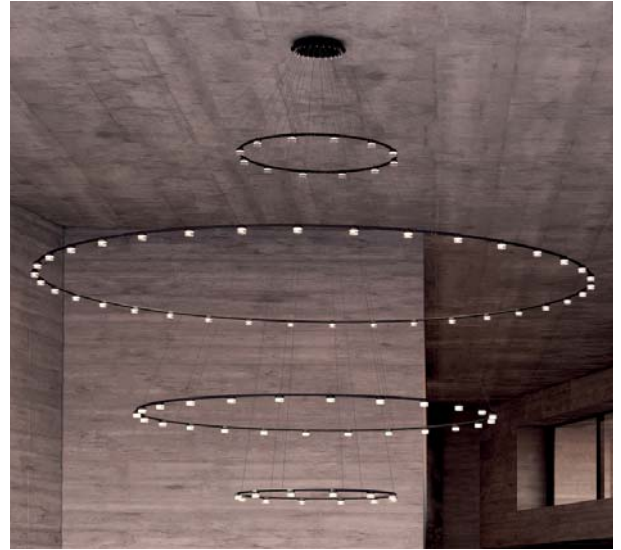

1701XX03

Instrucciones de montaje
Installation instructions

INSOLIT

Instalación y conexión / Installation and Connection

1

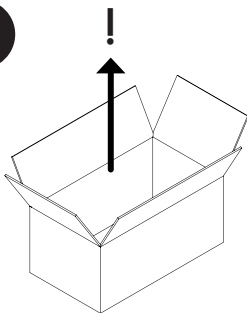

Desembalar el producto
Unpack the product

2

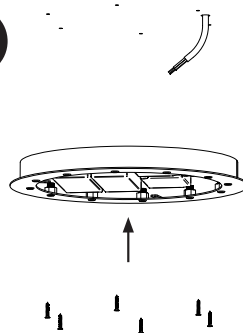

Fijar el florón al techo
Screw the ceiling canopy

3

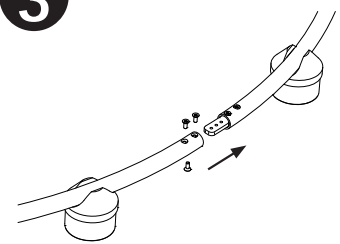

Ensamblar el aro (según modelo)
Assemble the ring (depending on the model)

4

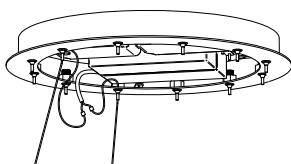

Realizar las conexiones eléctricas
Make the electrical connections

5

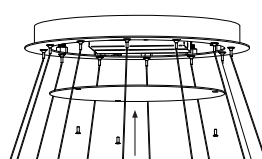

Atornillar la tapa del florón
Screw the ceiling canopy lid

6



! ON i

Encender la luminaria
Turn on the light



Lámpara circular sin cable de alimentación (alimentación por tensores). Fabricada en tubo de aluminio curvado de 2900 mm de diámetro. 24 módulos lumínicos de 4,2 W de potencia fabricados en aluminio mecanizado. Florón circular registrable para instalación en superficie.

Circular lamp without power cable (powerer by tensors). Made of 2900 mm diameter curved aluminum tube. 24 lighting modules of 4.2 W power made of machined aluminum. Registrable circular rosette for surface installation.

Código / Code	1702
Acabados / Finishes	01 Blanco / White 03 Negro / Black 05 Dorado / Golden
Luz / Light	27 LED 100,8W 9600lm 2700K 30 LED 100,8W 9600lm 3000K
Regulación / Dimmable	TRIAC
Opcional / Optional	Dimmable: DALI 1-10V Casambi (Control de la luz via Bluetooth y App) (Lighting control via Bluetooth and App)
Diseñador / Designer	GCA Architects
Año / Year	2024
Peso / Weight	9,5 kg
Material	Aluminio / Aluminium
Alimentación LED / LED tension	200/240V 50/60Hz
ICR / CRI	90
Dimensiones embalaje / Box Dimensions	260x110x10 cm

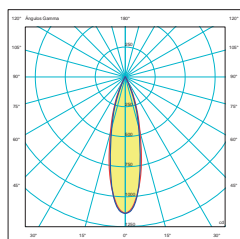

Instalación / Installation

Unión de los sectores mediante tornillos Allen M4 (Excepto Dew 600). Tornillos de fijación del florón no incluidos de serie. Cables de suspensión / alimentación protegidos.

Union of the ring sectors using M4 Allen screws (Except Dew 600). Ceiling fixing screws not included as standard. Protected suspension / power cables.



Luz spots / Spot Light



Dimmable: TRIAC



Fotometrías completas disponibles en
Full photometrics on: www.insolitbcn.com

Fabricado según normativa EN60598-1 y regulaciones pertinentes.

Manufactured according EN60598-1 normative and relevant regulations.

Dew 290

GCA Architects

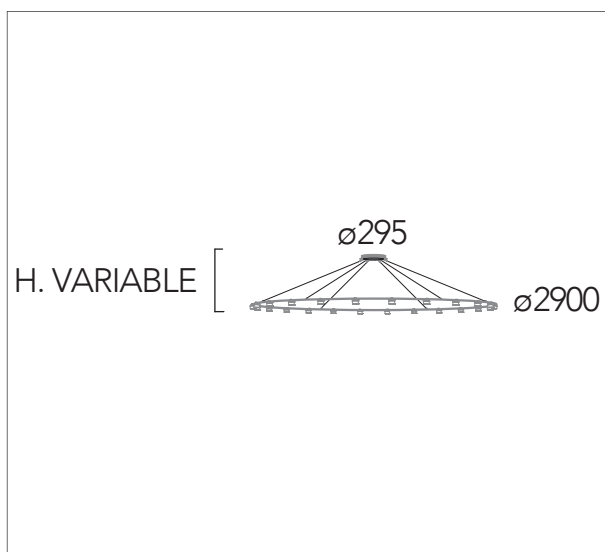

INSOLIT

c/ Cerignola, 13
08022 Barcelona
+34 932 507 640
insolit@insolitbcn.com
insolitbcn.com

Dew 290

GCA Architects



1702XX03

Instrucciones de montaje
Installation instructions

INSOLIT

Instalación y conexión / Installation and Connection

1

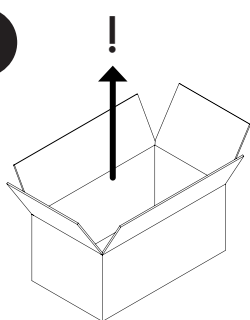

Desembalar el producto
Unpack the product

2

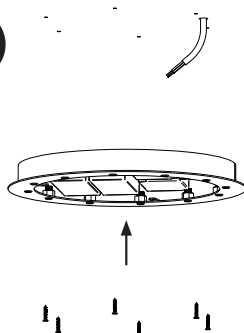

Fijar el florón al techo
Screw the ceiling canopy

3

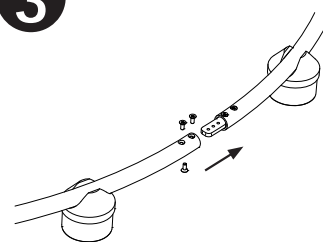

Ensamblar el aro (según modelo)
Assemble the ring (depending on the model)

4

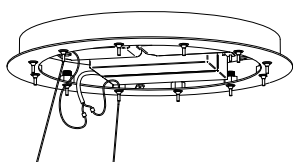

Realizar las conexiones eléctricas
Make the electrical connections

5

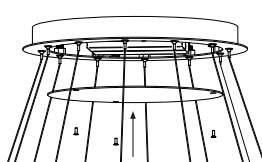

Atomillar la tapa del florón
Screw the ceiling canopy lid

6



! ON !

Encender la luminaria
Turn on the light



Lámpara circular sin cable de alimentación (alimentación por tensores). Fabricada en tubo de aluminio curvado de 4500 mm de diámetro. 36 módulos lumínicos de 4,2 W de potencia fabricados en aluminio mecanizado. Florón circular registrable para instalación en superficie.

Circular lamp without power cable (powerer by tensors). Made of 4500 mm diameter curved aluminum tube. 36 lighting modules of 4.2 W power made of machined aluminum. Registrable circular rosette for surface installation.

Código / Code	1703
Acabados / Finishes	01 Blanco / White 03 Negro / Black 05 Dorado / Golden
Luz / Light	27 LED 151,2W 14400lm 2700K 30 LED 151,2W 14400lm 3000K
Regulación / Dimmable	TRIAC
Opcional / Optional	Dimmable: DALI 1-10V Casambi (Control de la luz via Bluetooth y App) (Lighting control via Bluetooth and App)
Diseñador / Designer	GCA Architects
Año / Year	2024
Peso / Weight	13,9 kg
Material	Aluminio / Aluminium
Alimentación LED / LED tension	200/240V 50/60Hz
ICR / CRI	90
Dimensiones embalaje / Box Dimensions	240x90x10 cm

H. VARIABLE [ ø355 ø4500]

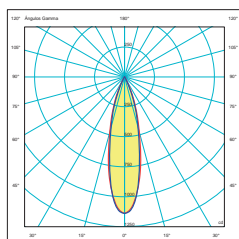

Instalación / Installation

Unión de los sectores mediante tornillos Allen M4 (Excepto Dew 600). Tornillos de fijación del florón no incluidos de serie. Cables de suspensión / alimentación protegidos.

Union of the ring sectors using M4 Allen screws (Except Dew 600). Ceiling fixing screws not included as standard. Protected suspension / power cables.



Luz spots / Spot Light



Dimmable: TRIAC



Fotometrías completas disponibles en
Full photometrics on: www.insolitbcn.com

Fabricado según normativa EN60598-1 y regulaciones pertinentes.

Manufactured according EN60598-1 normative and relevant regulations.

Dew 450

CGA Architects

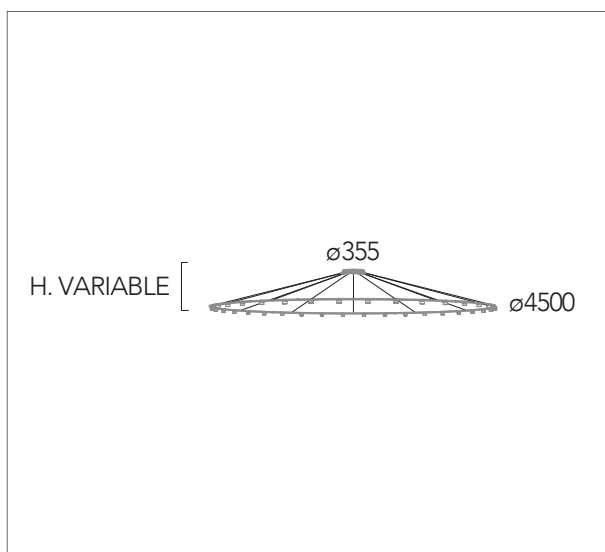

INSOLIT

c/ Cerignola, 13
08022 Barcelona
+34 932 507 640
insolit@insolitbcn.com
insolitbcn.com

Dew 450

GCA Architects



1703XX03

Instrucciones de montaje
Installation instructions

INSOLIT

Instalación y conexión / Installation and Connection

1

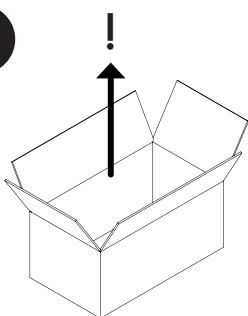

Desembalar el producto
Unpack the product

2

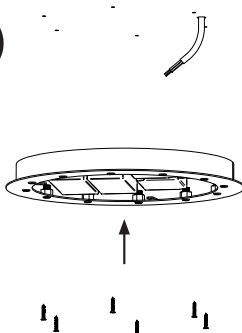

Fijar el florón al techo
Screw the ceiling canopy

3

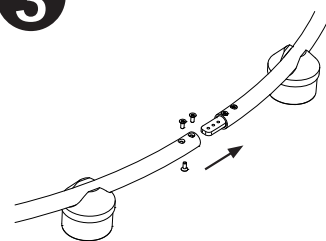

Ensamblar el aro (según modelo)
Assemble the ring (depending on the model)

4

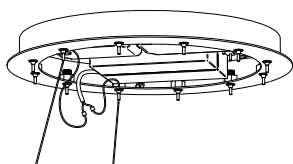

Realizar las conexiones eléctricas
Make the electrical connections

5

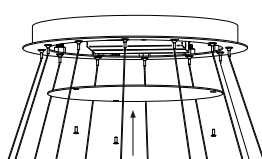

Atornillar la tapa del florón
Screw the ceiling canopy lid

6



! ON i

Encender la luminaria
Turn on the light